

# The Computational Creativity Curriculum

Lee Spector, Chris Perry & Jaime Dávila  
Hampshire College, Amherst, MA

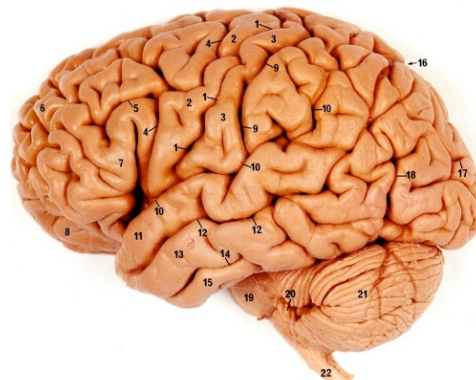
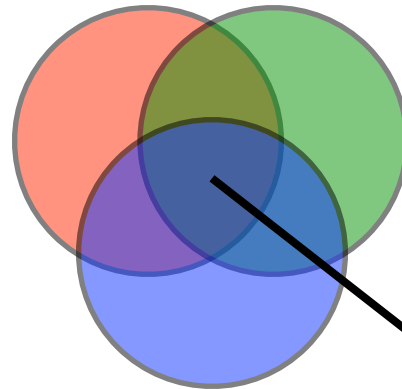
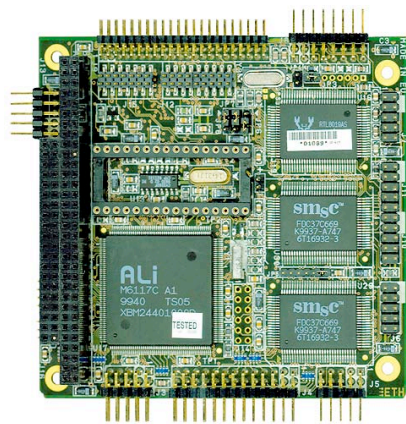

Computational  
Creativity  
Systems

# User-Guided Variation

- Generate/refine variations with a user-driven computational model of creativity
- Interdisciplinary art/sci/tech student/faculty development (piloted in *Computing Concepts: Creative Machines?* and *Radical Innovation in Digital Arts*)
- Use existing art-making software (*Maya, RenderMan, Shake, Photoshop, MaxMSP, Processing, ...*)
- Browser interface, cluster back end
- Community college and high school outreach

# Real Creativity

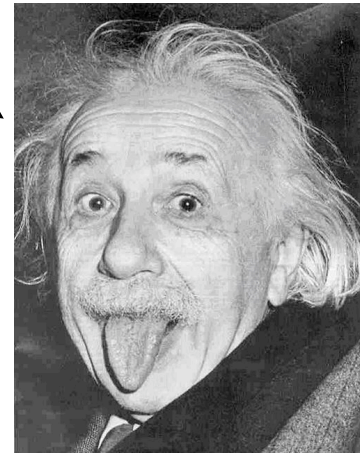
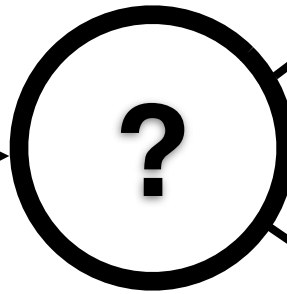
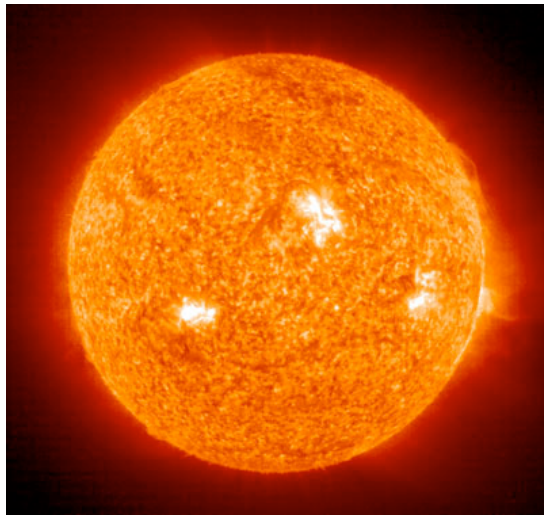

GECCO Humies

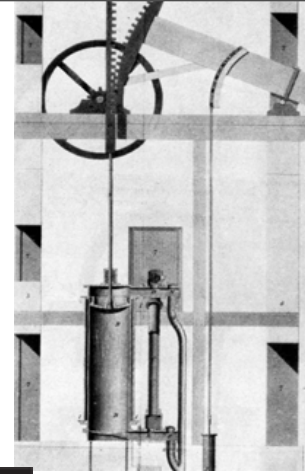
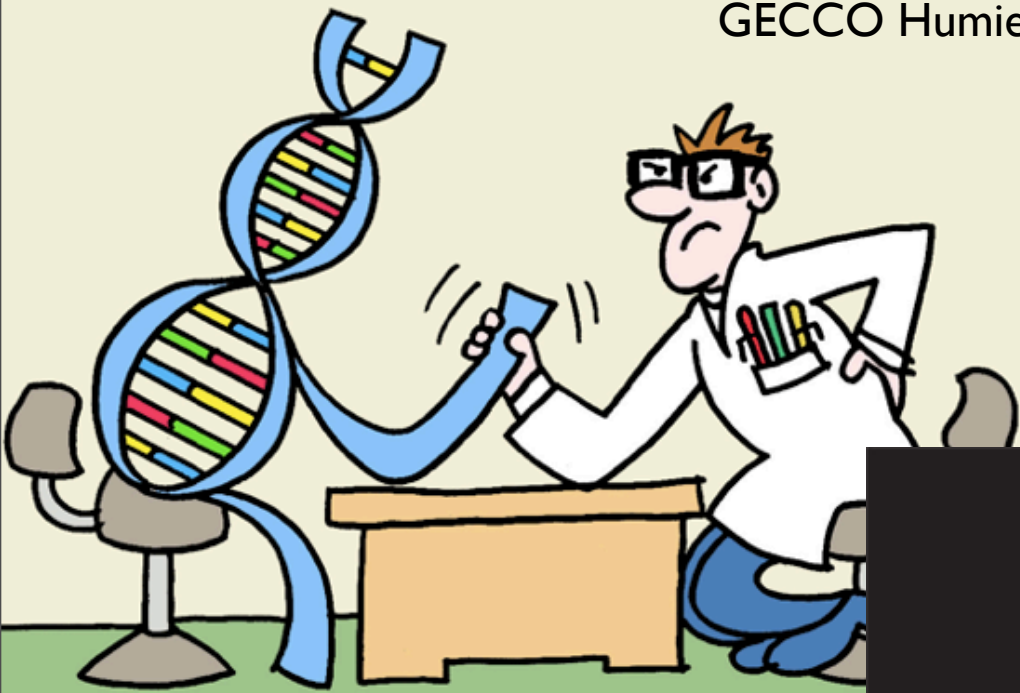

(a)

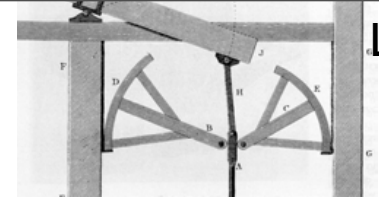

(b)

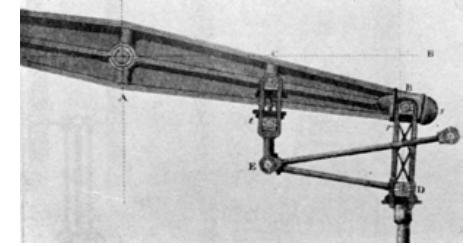

(c)

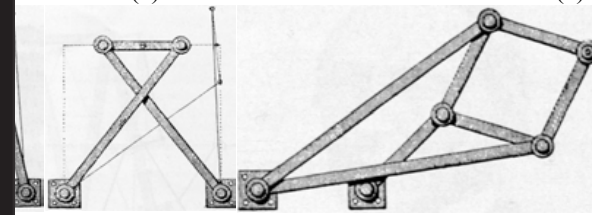

(e)

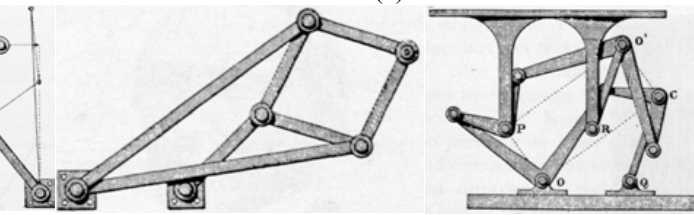

(f)

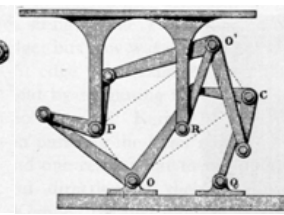

(g)

Lipson

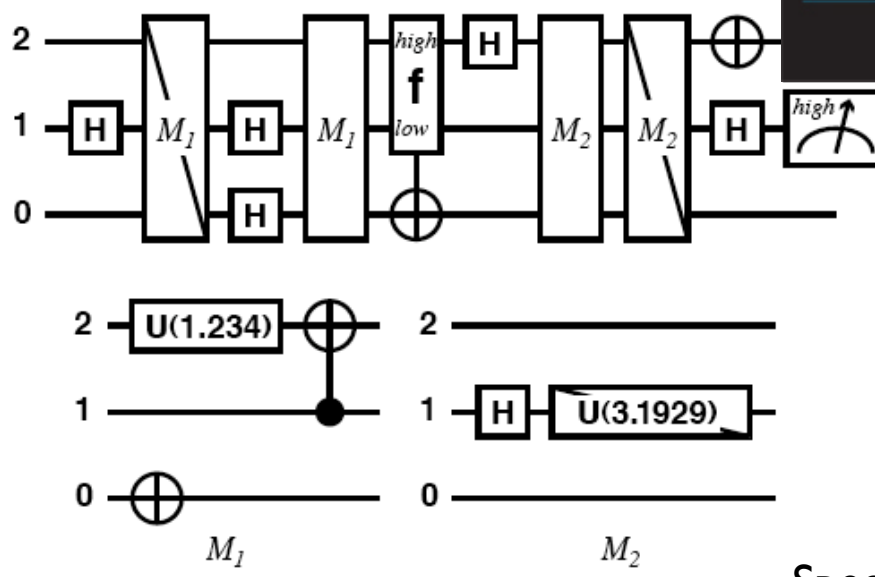

Spector

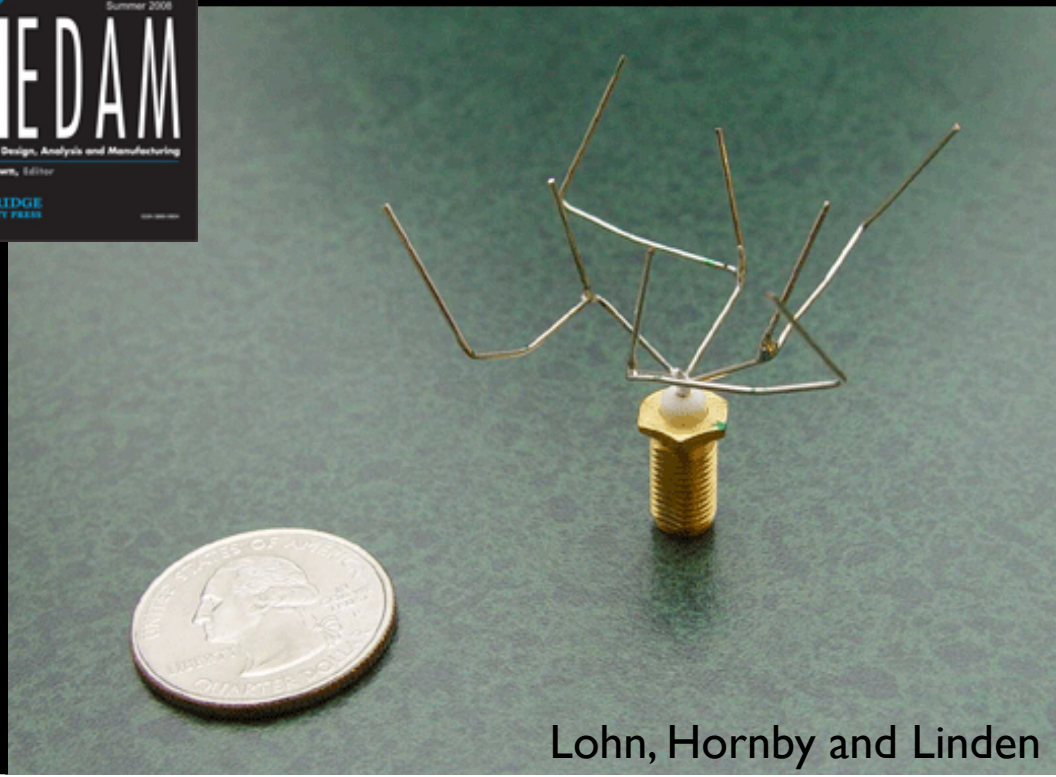

Lohn, Hornby and Linden

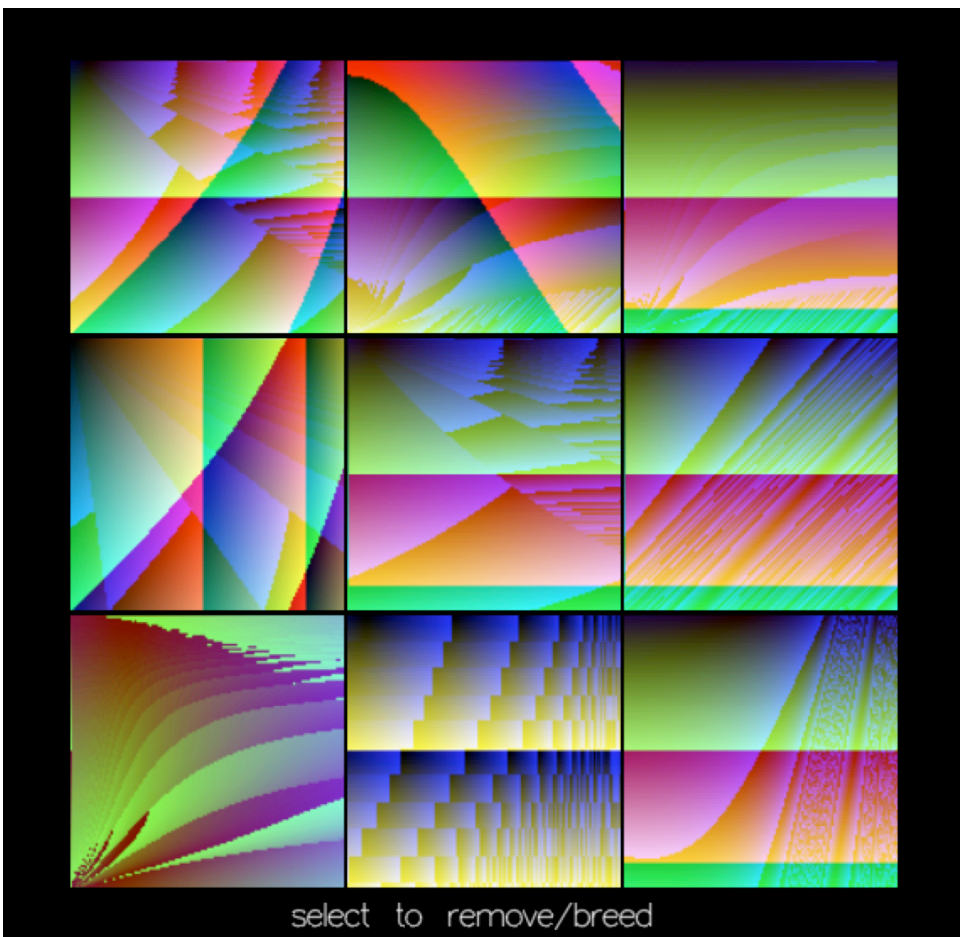

u2\_01

http://anim.hampshire.edu/wc/viewshot.php?shot\_id=8

Latest Headlines Tower 37 RenderMan Perry Hampshire Tcl/Tk 8.4 Manual cgi.tcl - Home page Art 740 Coblyn Depa... DreamWorks Animati...

Shots

General Models Farm myHELGA Admin Producer Tools Log Out Switch Show: Tower 37

HELGA PROJECT MANAGEMENT

Back to browsing shots Previous Shot Next Shot

Anim Fix Compositing Film-out

Edit Shot Info

Side of the water tower as Mule and Leed climb up the tower and past the camera.

Shot Name: u2\_01

Shot Type: Medium

Duration: 350 frames (24fps)

Edit Watch List

Igor Web UI

http://anim.hampshire.edu/igor/

Most Visited Getting Started Latest Headlines

Receiving new individuals... Session ID : 75 Gen ID : 1 Indivs In : 70

Settings End Session New Generation

15 14 12 15 9 4 1